

HANDVÄRK

F U R N I T U R E



The Collection

Tables · Lighting · Seating · Storage · Objects

The Collection



CONTENT

The Philosophy		5
Tables	Round Coffee Tables	11
	Coffee Table 90	17
	Console	19
	Dining Tables	21
	Marble	25
Lighting	Studio Series	29
	Globe Series	37
Seating	Paragon Series	45
	Modular Sofa	51
	Daybed	55
	Lounge Chair	59
	Piano Bench	61
	Grand Bench	63
	Leather	65
Storage	Phantom Shelving System	69
Objects	Shadow Mirror	75
	Rugs	79
The Designers		81
The Location		85



THE PHILOSOPHY

For a decade, HANDVÄRK FURNITURE has been creating modern and minimalistic furniture for aesthetically inclined individuals and the homes they inhabit. Our inspiration is and always will be the Bauhaus movement. Close to our heart, this style period embodies the idea that to be truly great, a design should be at least two things: beautiful and functional. From the sourcing of materials to the design of each HANDVÄRK piece, this principle of simplicity runs through all aspects of how, what, and why we create.

Emil Thorup, Founder & Designer



TABLES



ROUND COFFEE TABLE 60



Product Information

Design	Emil Thorup
Dimensions	H40 x W65 x D65 cm
Materials	Marble Top: Beige, Brown, Dark Grey or Black. Frame: Black powder coated steel or stainless steel. Black frame available with solid brass details.





ROUND COFFEE TABLE 90



Product Information

Design

Emil Thorup

Dimensions

H32 x W96 x D96 cm

Materials

Marble Top: Beige, Brown, Dark Grey or Black.
Frame: Black powder coated steel or stainless steel.
Black frame available with solid brass details.



COFFEE TABLE 90



Product Information

Design

Emil Thorup

Dimensions

H32 x W96 x D96 cm

Materials

Marble Top: Black, Green, White or Light Grey.
Frame: Black powder coated steel or stainless steel.
Black frame available with solid brass details.



CONSOLE



Product Information

Design

Emil Thorup

Dimensions

H75 x W185 x D50 cm

Materials

Marble Top: Black, Green, White or Light Grey.
Frame: Black powder coated steel.
Available with solid brass details.



DINING TABLES

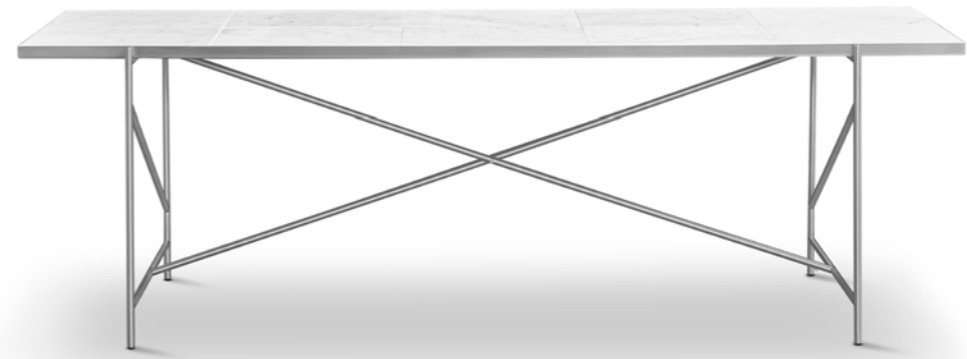

Product Information

Design

Emil Thorup

Dimensions

185: H74 x W185 x D96 cm
230: H74 x W230 x D96 cm

Materials

Marble Top: Black, Green, White or Light Grey.
Frame: Black powder coated steel or stainless steel.
Black frame available with solid brass details.



MARBLE

Favoured by the Roman and Greeks in art and architecture, marble has always been synonymous with sophistication and elegance. This jewel of nature is created under immense pressure and temperatures through a process taking millions of years. Crystallisation, veining, and differences in colour are beautiful irregularities that give each piece of marble its unique expression and character.

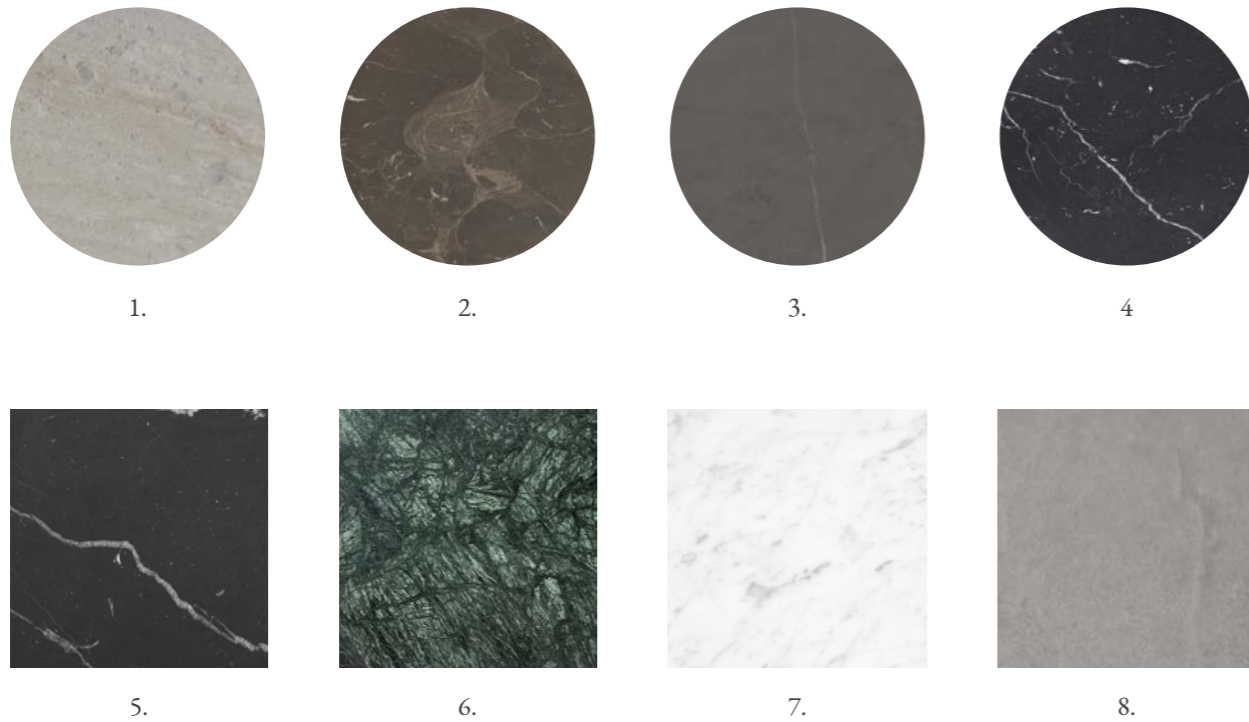

- 1. Beige - Rhine Grey (honed)
- 2. Brown - Emperador (honed)
- 3. Dark Grey - Pietra Grey (honed)
- 4. Black - Nero Marquina (honed)
- 5. Black - Nero Marquina (honed)
- 6. Green - Verde Guatamala (polished)
- 7. White - Carrara (honed)
- 8. Light Grey - Peony Grey (honed)



LIGHTING



STUDIO TABLE LAMP



Product Information

Design

HANDVÄRK FURNITURE

Dimensions

H50 x Ø25 cm

Materials

Black powder coated steel.
Available with knurled brass details.

Technical

1.7m cord. Compatible with G45 E14 bulb, max 15W.



STUDIO FLOOR LAMP



Product Information

Design

Laura Bilde

Dimensions

H165 x W30 x Ø25 cm

Materials

Black powder coated steel.
Available with knurled brass details.

Technical

2m cord. Compatible with A60 E14 bulbs, max 15W.
Available with set of Diffusers.

Studio Floor Lamp by Laura Bilde

The Studio Floor Lamp designed by Laura Bilde has an industrial look directly inspired by traditional photo lamps, serving as a photogenic statement piece for any living space. Laura Bilde is a Danish designer based in Copenhagen. Working in the intersection between the functional and the sculptural, she creates objects, furniture, and installations.

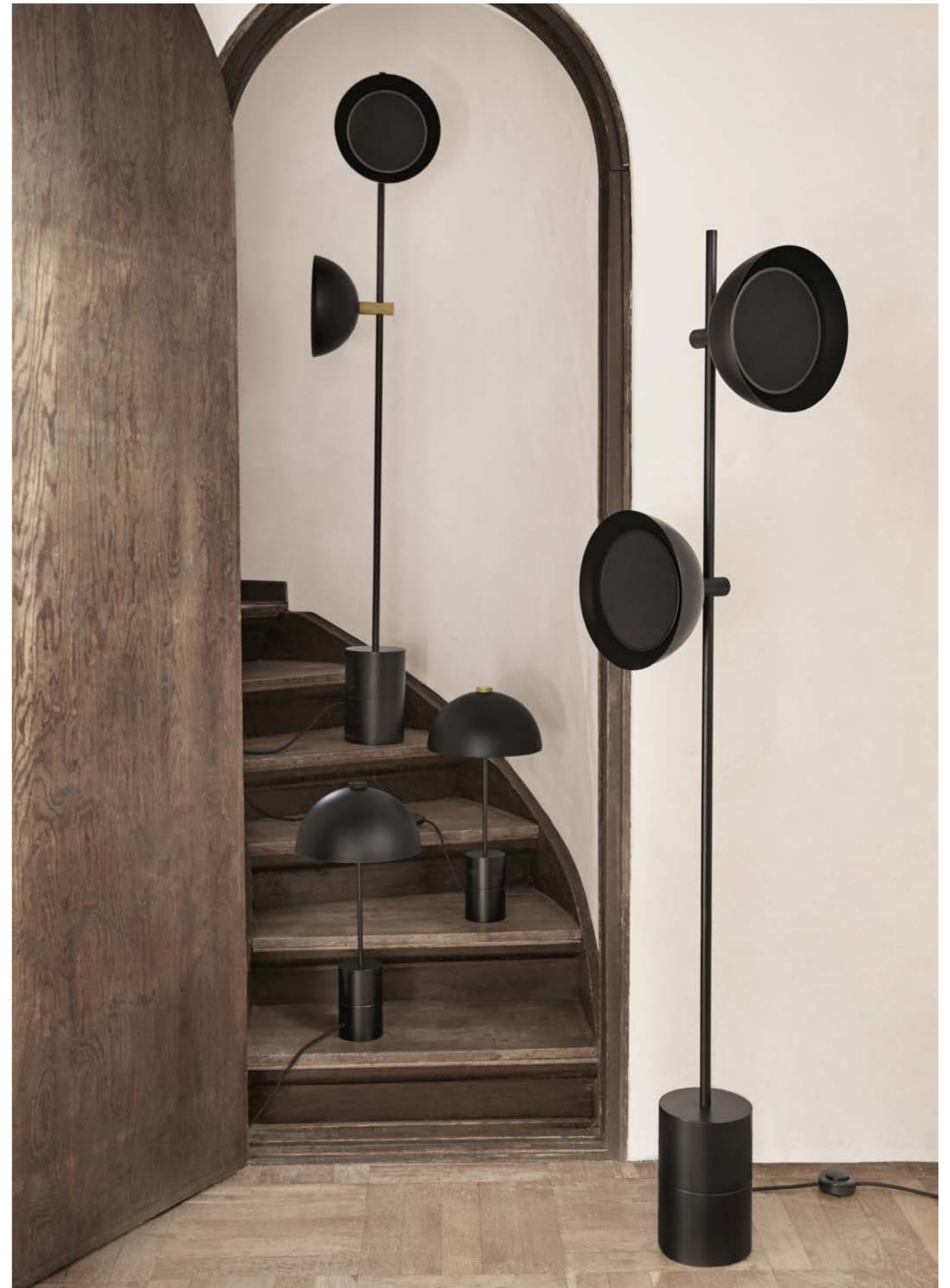
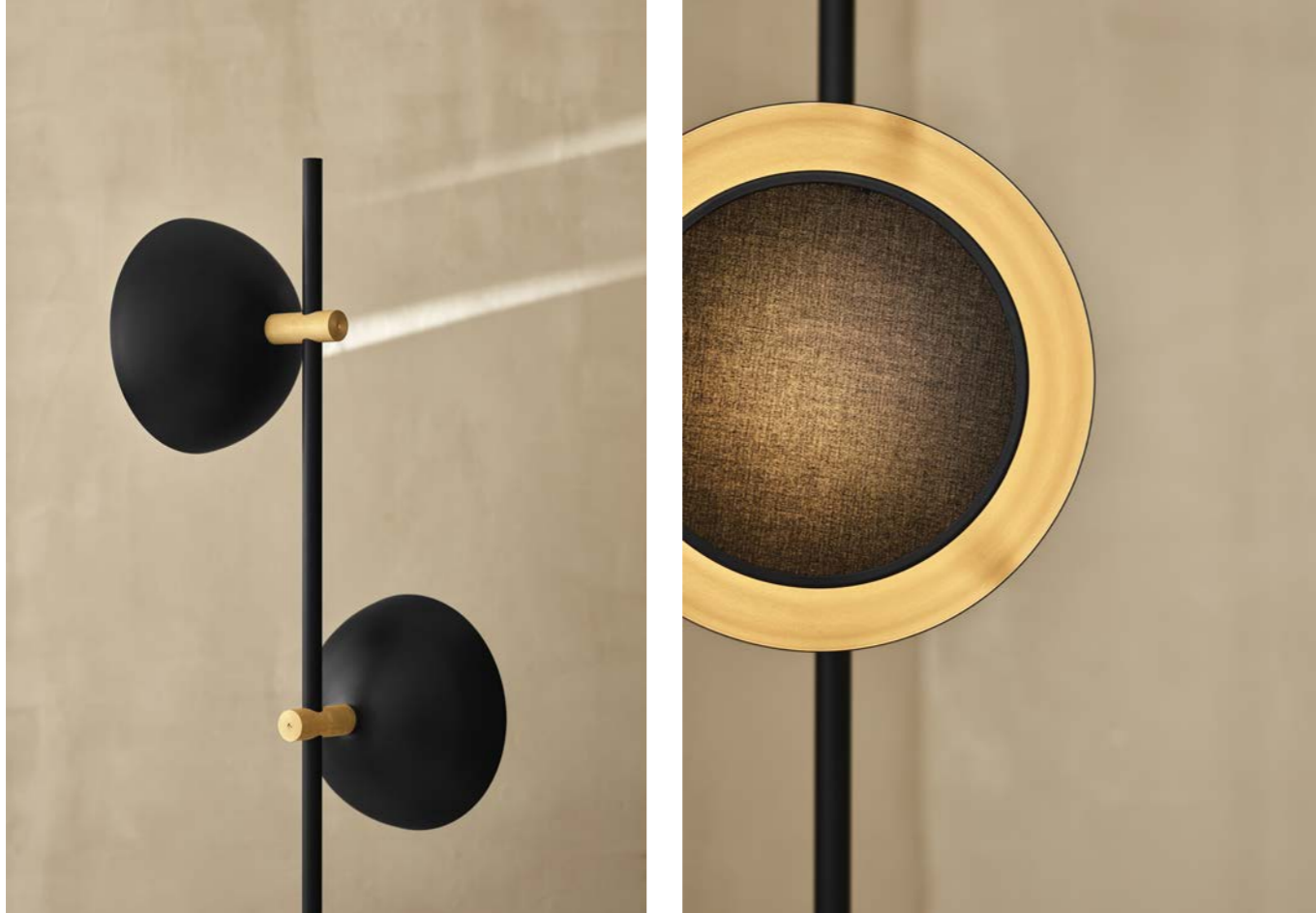



PENDANTS



Product Information

Design

Emil Thorup

Dimensions

Ø25 cm
Ø40 cm
Ø50 cm

Materials

Black powder coated steel.
Available with knurled brass details.

Technical

Ø25: 3m cord. Compatible with A60 E14 bulb, max 15W.
Ø40: 3m cord. Compatible with G95 E27 bulb, max 28W.
Ø50: 3m cord. Compatible with G120 E27 bulb, max 28W.



GLOBE FLOOR LAMP

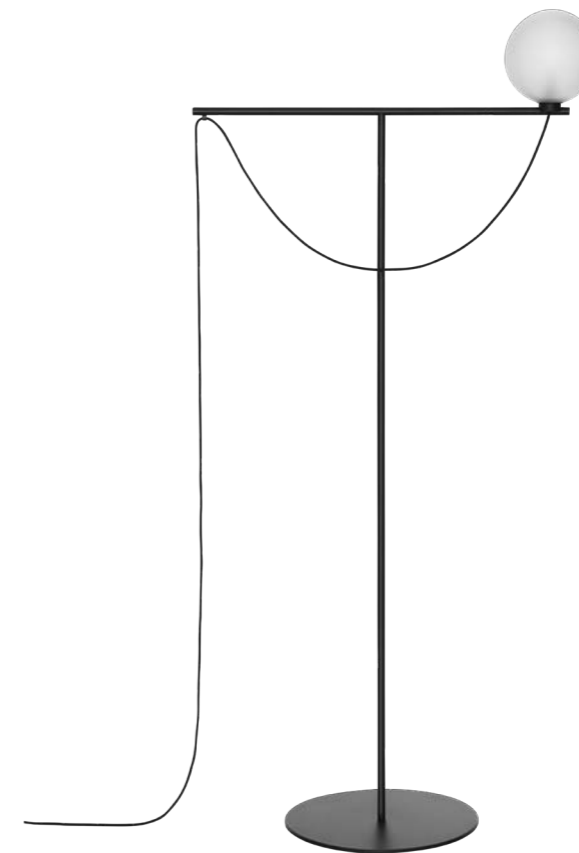

Product Information

Design

Emil Thorup

Dimensions

H175 x W86 x D43 x Ø19 cm

Materials

Black powder coated steel frame and mouth blown glass sphere.

Technical

3.5m cord. Compatible with G9 bulb, max 3.5W.



3-GLOBE CHANDELIER



Product Information

Design	Emil Thorup
Dimensions	W83 x D74 x Ø19 cm
Materials	Black powder coated steel frame and mouth blown glass spheres.
Technical	2.5m wire, 3.5m cord. Compatible with G9 bulbs, max 3.5W.



6-GLOBE CHANDELIER

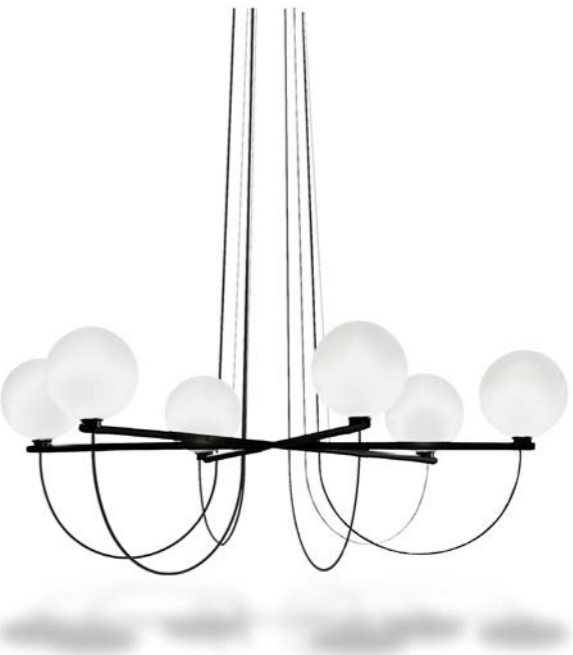

Product Information

Design	Emil Thorup
Dimensions	W132 x D132 x Ø19 cm
Materials	Black powder coated steel frame and mouth blown glass spheres.
Technical	4m wire, 5m cord. Compatible with G9 bulbs, max 3.5W.

SEATING



PARAGON CHAIR



Product Information

Design	Says Who
Dimensions	H80 x W49 x D44.5 cm Seat height 45.8 cm
Materials	Premium veneer in Natural Oak, Smoked Oak or Black Oak



PARAGON BAR STOOL



Product Information

Design

Says Who

Dimensions

H65.5 x W38.5 x D31 cm

Materials

Premium veneer in Natural Oak, Smoked Oak or Black Oak

Paragon by Says Who

The Paragon Series is designed by Says Who – a design duo with a curious mind and a desire to create captivating solutions. The Paragon Chair's purpose is to be light and slender, yet sturdy and strong. Its harmonic balance in both dimensions and proportions gives the chair its universal appeal, making it a natural choice for anyone looking to add a bit of functional brilliance to their décor.





MODULAR SOFA



Product Information

Design

Emil Thorup

Dimensions

See options on page 52

Materials

Soho, Copenhagen or Sapphire

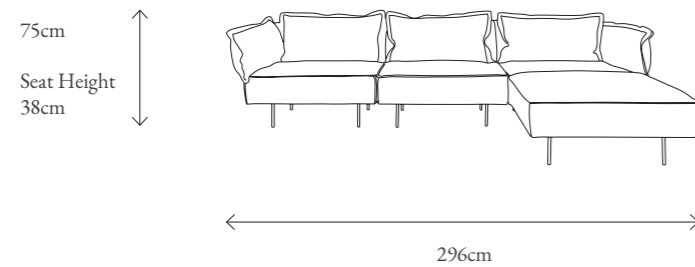
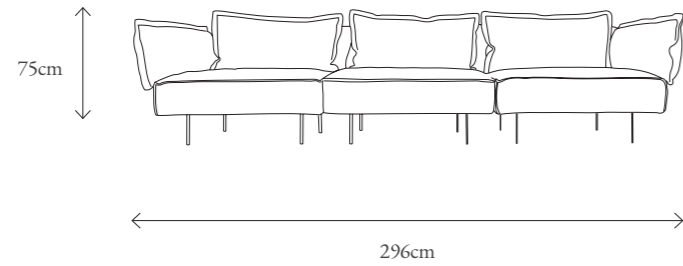
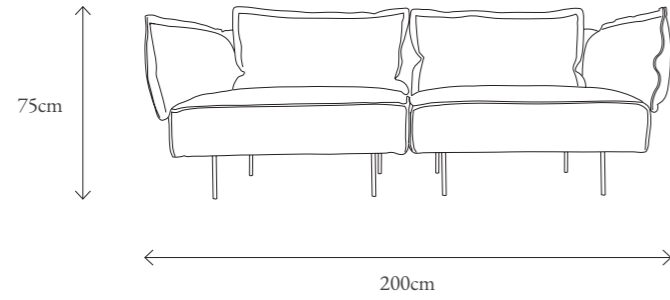
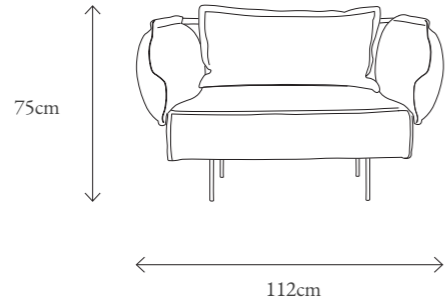

1.



2.



3.

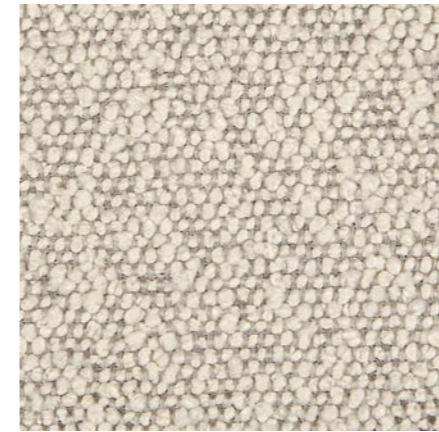

4.



5.



6.



7.



8.



9.

- 1. Chalk - Soho 901
- 2. Concrete - Soho 805
- 3. Coal - Soho 800

- 4. Cloud - Copenhagen 901
- 5. Earth - Copenhagen 904
- 6. Soil - Copenhagen 903

- 7. Sand - Sapphire 904
- 8. Royal Blue - Sapphire 606
- 9. Dark Grey - Sapphire 802



DAYBED



Product Information

Design

Emil Thorup

Dimensions

H34 x W188 x D85 cm

Materials

Leather Top: Sørensens Leather or Mastrotto Black.
Frame: Black powder coated steel or stainless steel.
Black frame available with solid brass details.





LOUNGE CHAIR



Product Information

Design

Emil Thorup

Dimensions

H65 x W75 x D72 cm
Seat height 32 cm

Materials

Leather Cushions: Sørensens Leather or Mastrotto Black.
Frame: Black powder coated steel or stainless steel.



PIANO BENCH



Product Information

Design	Emil Thorup
Dimensions	H47 x W95 x D45 cm
Materials	Leather Top: Sørensens Leather or Mastrotto Black. Frame: Black powder coated steel or stainless steel. Black frame available with solid brass details.



GRAND BENCH



Product Information

Design	Emil Thorup
Dimensions	H47 x W140 x D45 cm
Materials	Leather Top: Sørensens Leather or Mastrotto Black. Frame: Black powder coated steel or stainless steel. Black frame available with solid brass details.

LEATHER

Our upholstery is made using the highest quality leather from Sørensen Leather. All pieces can be made to order in aniline, semi-aniline, and protected leather. Each type has its own characteristics and beauty marks such as insect bites, scars, and wrinkles, all giving this natural material its own distinct character and identity.



STORAGE



PHANTOM SHELVING SYSTEM

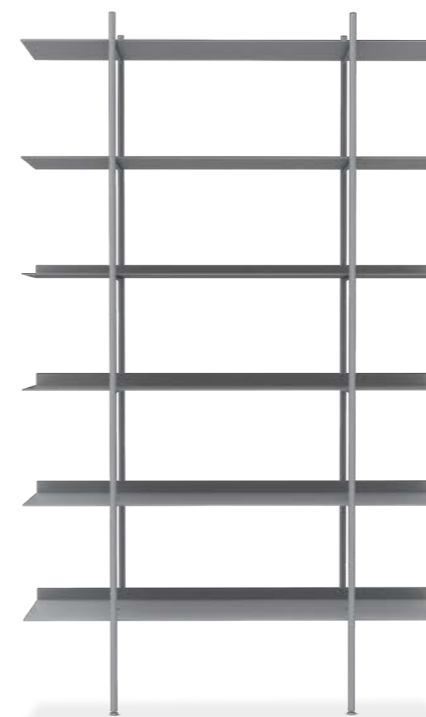

Product Information

Design

Emil Thorup

Dimensions

Small: H104 x W123 x D36 cm
Large: H204 x W123 x D36 cm

Materials

Powder coated steel in Black, White or Grey.



OBJECTS



SHADOW MIRROR



Product Information

Design	Aleksej Iskos
Dimensions	W80 x H180 cm
Materials	Aluminium frame and mirror glass.
Technical	Can be wall mounted in portrait or landscape orientation.



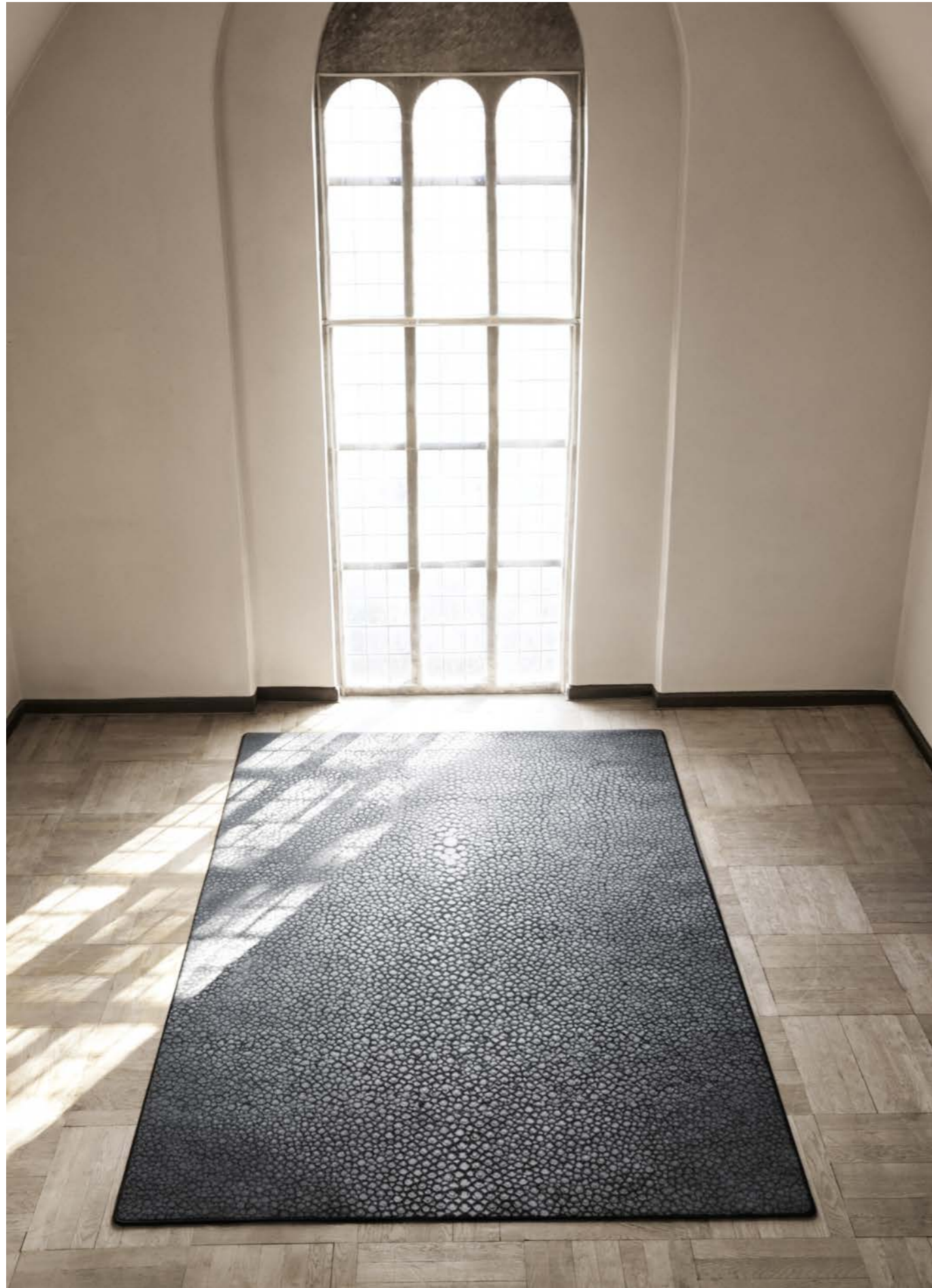

RUGS



Dark Spine Rug

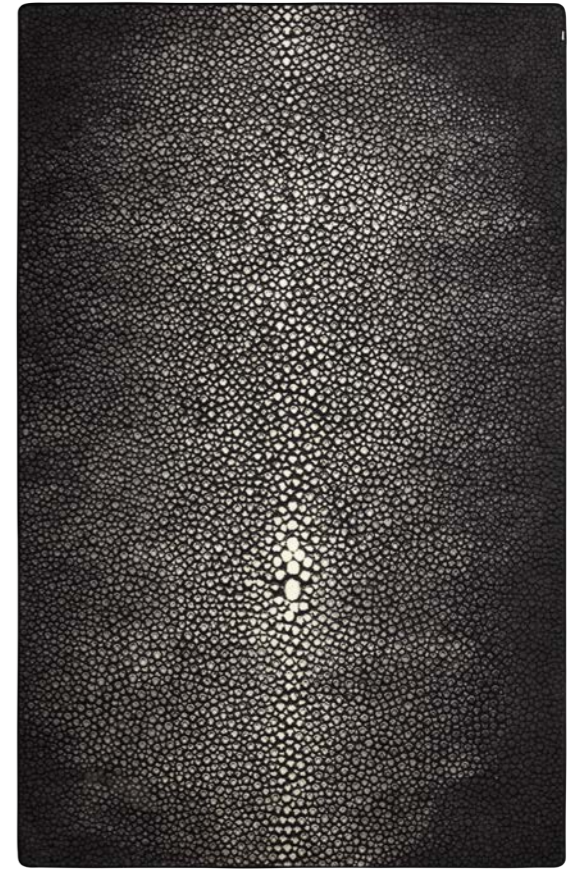

Stingray Rug

Product Information

Design

Camilla Stärk

Dimensions

H300 x W200 cm

Materials

80% New Zealand wool and 20% polyamid, tufted cut pile.

THE DESIGNERS



Emil Thorup

Founder of HANDVÄRK FURNITURE and designer of the first collection, autodidactic Emil Thorup with a lifelong passion for architecture and aesthetics, is greatly inspired by the Bauhaus movement. In his design he strives to minimize unnecessary theatrics whilst still pursuing a Nordic warmth.

Design	Daybed Globe Series Modular Sofa Marble Tables Phantom Shelving System
--------	--



Says Who

Kasper Meldgaard and Nikolaj Duve founded SaysWho back in 2010. Their solid business understanding and a wide array of skills within design, construction, and engineering made them a great team from the start. Their desire to make smart and innovative solutions define their concepts. They use 3D as a concept development tool to verify and balance surfaces, shapes with construction and comfort.

Design Paragon Series



Laura Bilde

Laura is a freelance designer based in Copenhagen. With a strong grasp on concept, materiality and form, Laura works across both product and interior design. She's driven by tactility, curiosity and design that can be experienced both on a physical and emotional level.

Design Studio Floor Lamp



Camilla Stærk

Born and raised in the countryside of Denmark, Camilla Stærk studied fashion and textiles at Ravensbourne College in London. The sophisticated, dark romance of her women's and men's ready-to-wear, accessories and interiors have earned her the British Fashion Council's Newgen Award, collaborations with top fashion brands and hotels, multimedia solo art exhibitions and dedicated collectors from London to Tokyo to the Americas.

Design Dark Spine Rug
Stingray Rug



Aleksej Iskos

Aleksej Iskos was born in Ukraine and since 1991 lives and works in Copenhagen, Denmark. Graduated from The Royal Danish Academy of Fine Arts, School of Design. Since 2010 co-founder and partner at Iskos-Berlin Design. In 2018 established Iskos Design. Aleksej appreciates design not only for its practical purpose, but also for what it communicates to us, for the emotions it creates, for the memories it awakes - for the story it tells us. To tell this story, the designer appeals to both sense and sensibility, and the function becomes poetry. It is this poetry we fall in love with.

Design Shadow Mirror



THE LOCATION

The collection was shot at Maglemosevej 20: The legendary sculptor Axel Poulsen's home in Charlottenlund, Copenhagen, where art is chiselled, painted, and cut directly into the walls, ceilings, stairs, and furniture. The artwork on Maglemosevej 20 is, at least figuratively speaking, Poulsen's greatest masterpiece. To this day, it stands with many of his sculptures and works as an eternally valid testimony of one Denmark's finest artists.





HANDVÄRK FURNITURE

Aarhusgade 136A
2150 Nordhavn
Copenhagen Denmark

+ 45 31 73 12 23
info@handvark.com
www.handvark.com

Copyright HANDVÄRK ApS
Photography: Signe Bay
Styling: Sidsel Rudolph
Graphic: Frederik Øst

HANDVÄRK

F U R N I T U R E