

BAUX

Acoustic Ceiling Installation manual

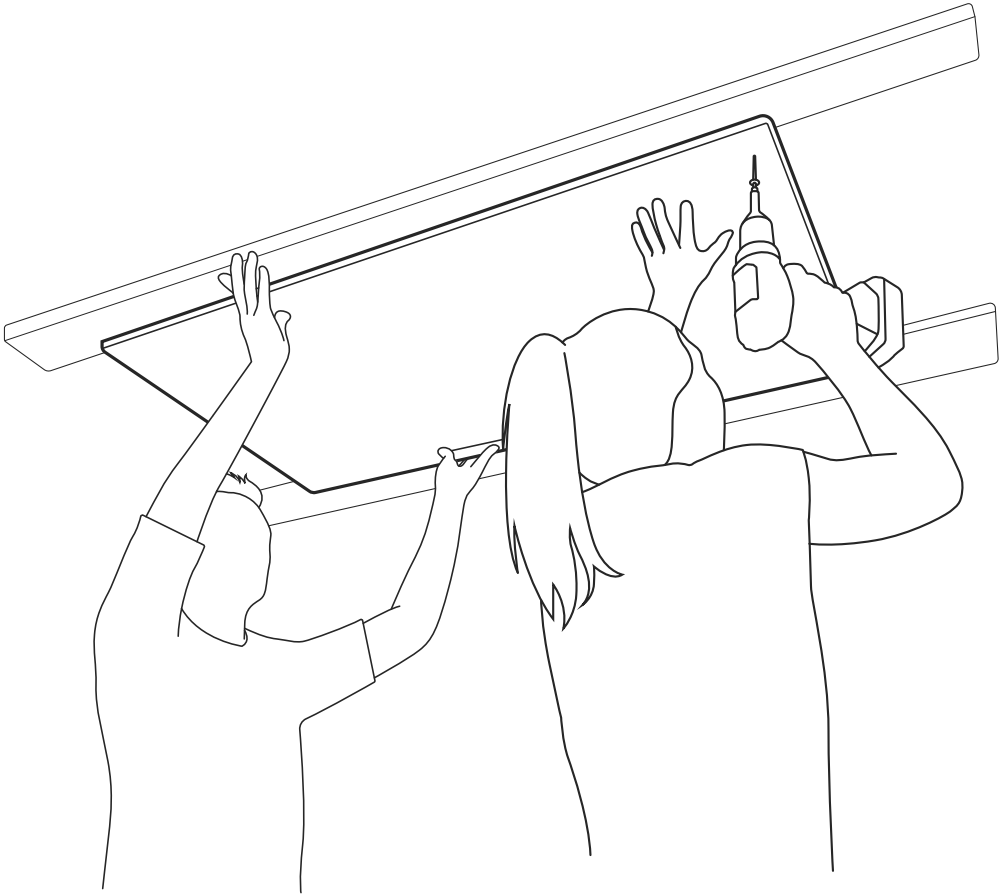

Installation methods:



A) Concealed
using wood battens



B) Concealed
using Drywall Grid

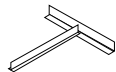

C) Exposed
using Lay-In Grid

About the material

BAUX Acoustic Wood Wool is a functional, natural material made from two of the world's oldest building materials, wood and cement. The combination is simple and ingenious. Wood fiber offers excellent insulation, heat retention and sound absorption. BAUX is made from certified wood – FSC® and PEFC™ – guaranteeing that it can be traced back to responsible forestry operations. Cement, a proven and popular building material, is the binder that provides strength, moisture resistance and fire protection. The result is a product that's versatile and durable in all climates.

Preparations

- ✓ **Inspect the materials carefully** and report any damages to BAUX immediately.
- ✓ **Store the wood wool panels indoors** in a dry environment before installation.
- ✓ **Unwrap and acclimatize the products** in intended installation space at least 48 hrs.
- ✓ **During installation**, make sure that panels and ceilings are dry and clean.
- ✓ **If a vapor barrier is needed**, install inbetween the ceiling and the panels.
- ✓ **Ensure you have the appropriate tools & materials** to complete the installation:

-  Grid or battens.
-  Cordless screwdriver.
-  Measuring tape- or rod.
-  BAUX Ceiling panels.
-  BAUX Paint and brush.
-  Saw (the kind you prefer)

Screws

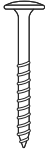

	Length: 45 mm (1.77")	Diameter: Ø 4.2 mm (Ø 0.16")
	Min. required screws: 6 per panel	

Adapting the panels

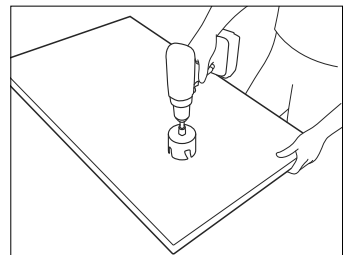
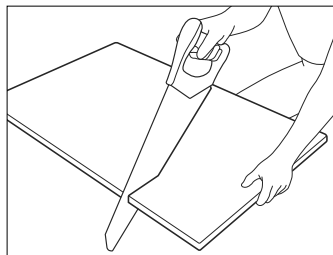
You can easily adapt the BAUX Wood Wool Ceiling panels by simply sawing them. For holes, we recommend a minimum margin of at least 30 mm (1.18") to the edge, to avoid that the material cracks or falls off.



Choose an installation method:

- A)  Concealed, using wood battens page 4
-
- B)  Concealed, using Drywall Grid page 7
-
- C)  Exposed, using Lay-In Grid page 11
-

Method A:
Concealed, using wood battens

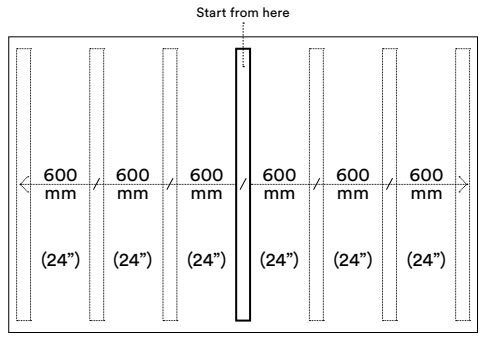
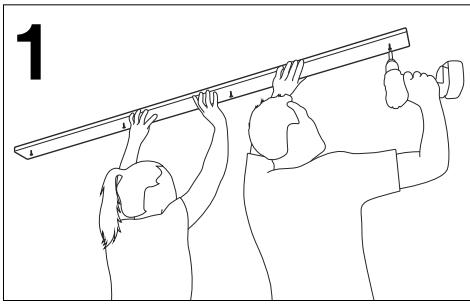

First install the wood battens. Begin from the center of the room and then continue outwards. Make sure the distance in between each batten is c-c 600 mm (24").

2 Choose the direction of your ceiling panels and start installing:

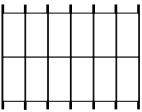

Option A: Vertical

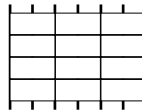

Option B: Horizontal

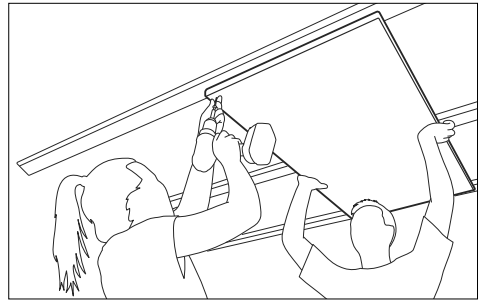
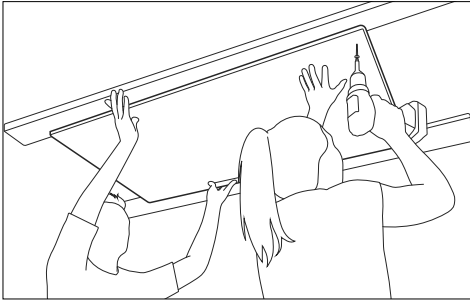

Install the first panel, starting from the center of the room. You will need 6 screws per panel, mounted in each corner and at the center of the panel, 25 mm (1.0") from the edge. Repeat the procedure for each panel, working your way outwards towards the edges of the room, until you only have the last row left.

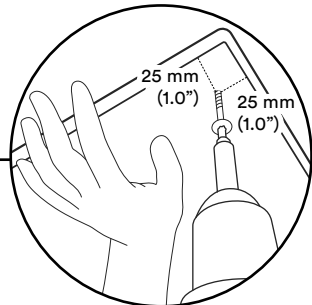
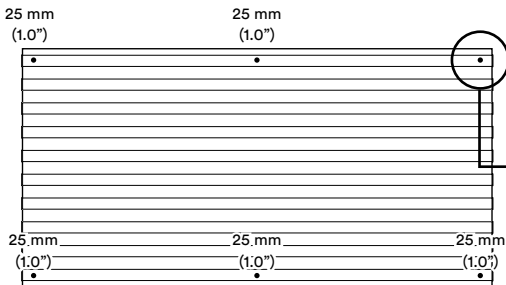

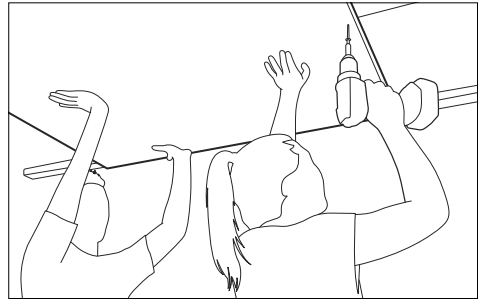
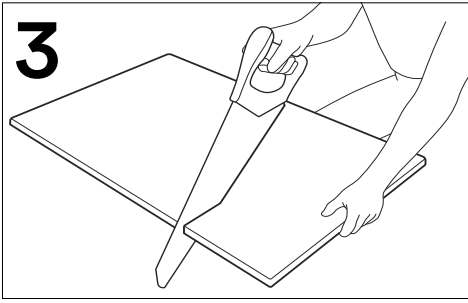

For the last rows of ceilings panels, at the very edge of the room, you will need to measure and adapt the remaining ceiling panels to fit. Simply saw the ceiling panels according to your measurements, and then install them the same way you did with the rest.

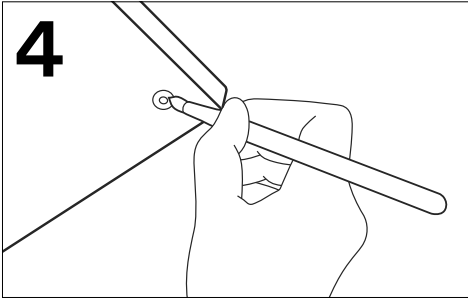

When the entire ceiling is installed, use the BAUX paint and brush to color the screw heads the same way as the ceiling panels, it makes all the difference!

Need help?

For very specific installations or scenarios that aren't covered in this installation manual, visit baux.com or contact us at info@baux.com

Method B:
Concealed, using Drywall Grid

1 Do an inventory check to ensure you're not missing any parts

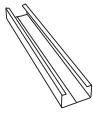

C-profile

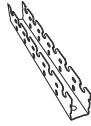

Click-on crossbar



Hanging rods

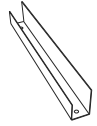

Perimeter trim



C-profile joint



Click-on joint



Hook with spring

2 Mark attachment points in the ceiling. Use the charts below to identify appropriate distances.

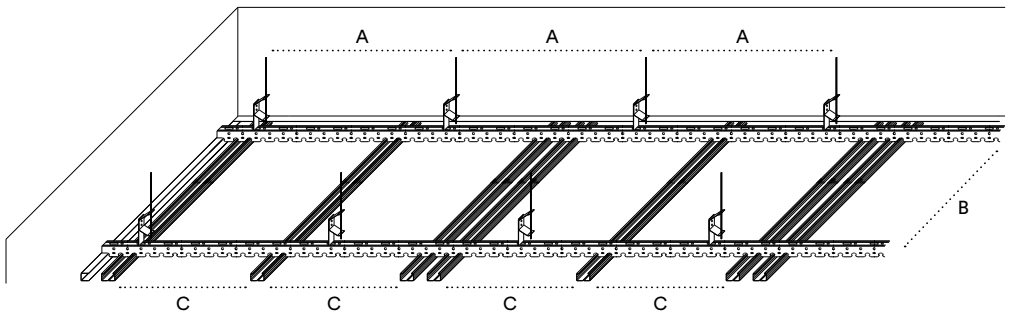

Distances between:

Hanging rods (A)

**Click-on
crossbars (B)**

Profiles (C)

900 mm*

1200 mm*

CC 600 mm*

*BAUX does not provide Concealed Drywall Grid in imperial US dimensions.

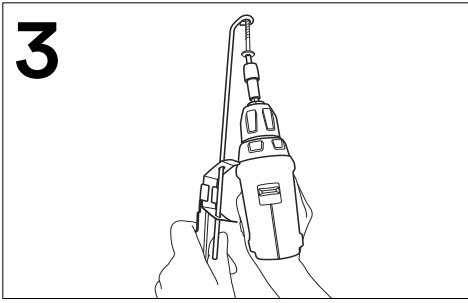

3

Attach hooks with springs on the hanging rods and mount them into the ceiling at your marked up attachment points. Adjust the mounting height.

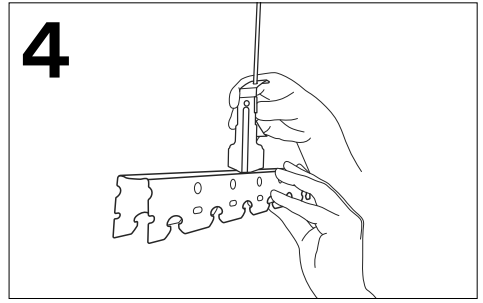

4

Attach the click-on crossbars. Extend them by attaching crossbar joints. Adjust the length with a metal cutter.

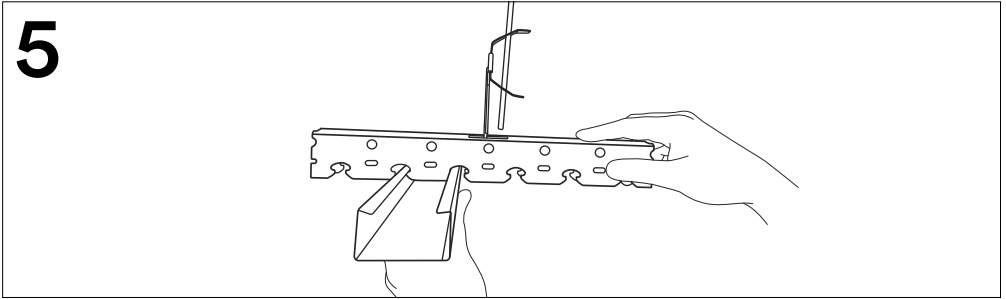

5

Attach the profiles with a distance of CC 600 mm. Extend them by attaching profile joints. Minimum 100 mm from the profile. Adjust the length with a metal cutter. Adjust the mounting height. Repeat until the entire grid is mounted in the ceiling.

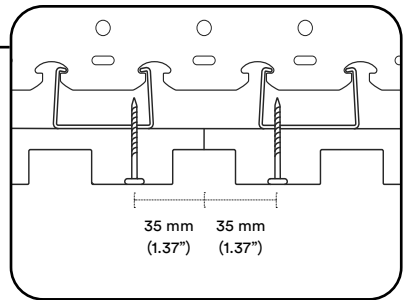
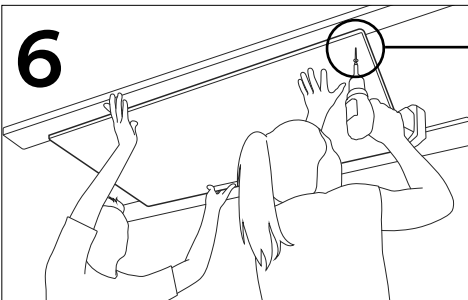

6

Install the first panel, starting from the center of the room. You will need 6 screws per panel, mounted in each corner and at the center of the panel, 35 mm from the edge. Repeat the procedure for each panel, working your way outwards towards the edges of the room, until you only have the last row left.

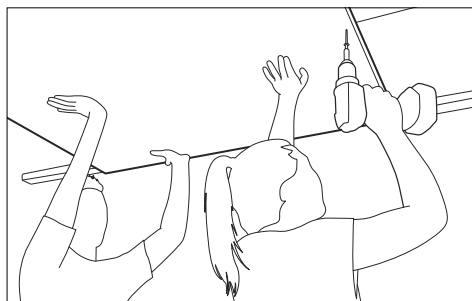
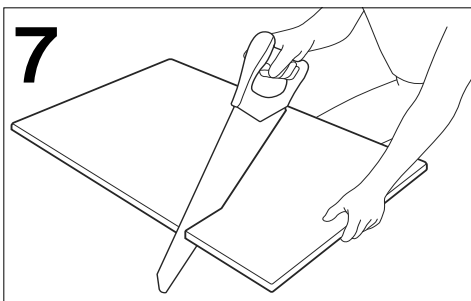

For the last rows of ceilings panels, at the very edge of the room, you will need to measure and adapt the remaining ceiling panels to fit. Simply saw the ceiling panels according to your measurements, and then install them the same way you did with the rest.

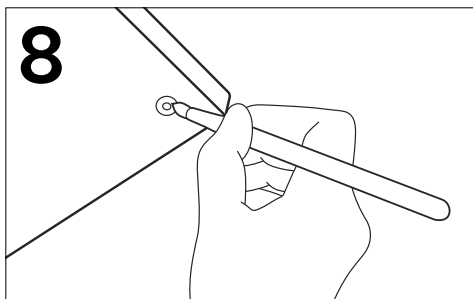

When the entire ceiling is installed, use the BAUX paint and brush to color the screw heads the same way as the ceiling panels, it makes all the difference!

Need help?

For very specific installations or scenarios that aren't covered in this installation manual, visit baux.com or contact us at info@baux.com

Method C:
Exposed, using Lay-In Grid

1 Do an inventory check to ensure you're not missing any parts

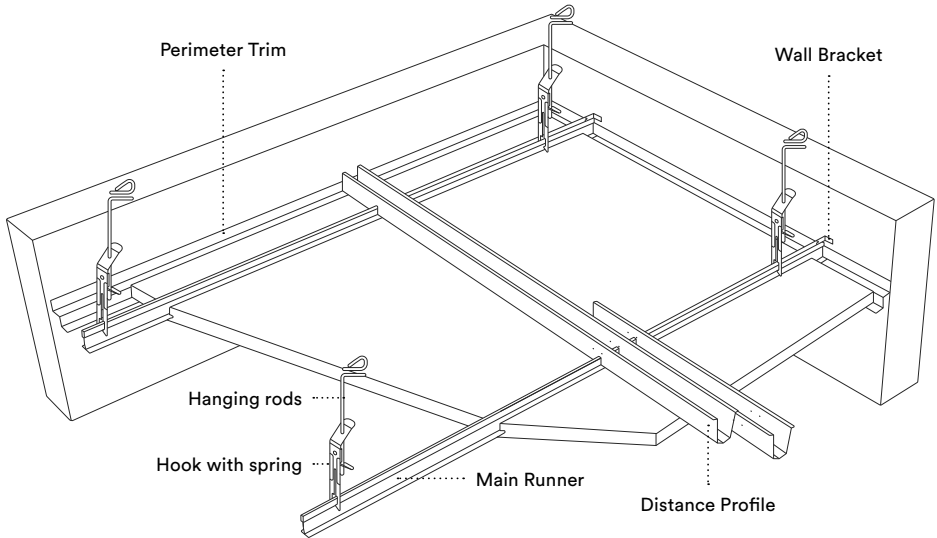

2 Mount the grid according to the following instructions:

- ✓ First hanging rod max 400 mm (15") from wall
- ✓ Distance between hanging rods max 1200 mm (2.0")
- ✓ Distance profiles c-c 1300 mm (52")
- ✓ Suspended minimum 150 mm (6.0") to allow demounting

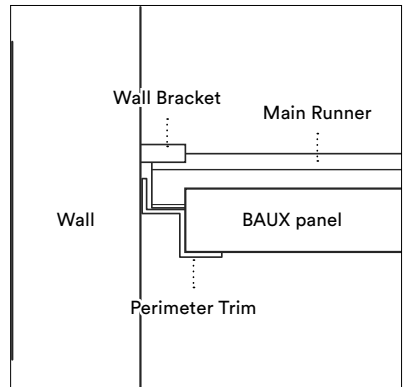

3 Place the ceiling panels into the grid

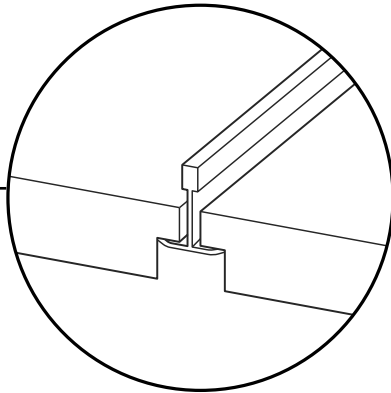
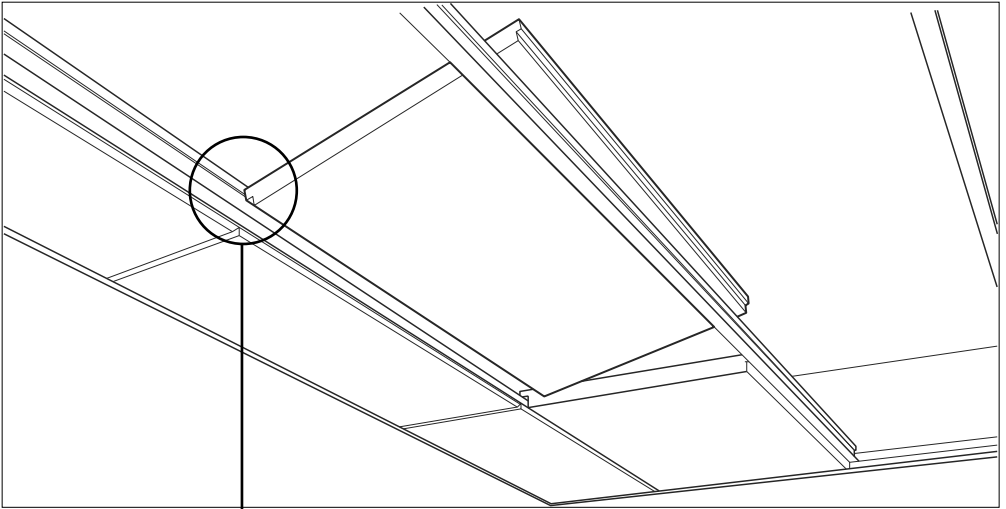

More about the product

Acoustic Performance

The open structure of the material reduces sound reflections which makes BAUX Acoustic Wood Wool a proven sound absorber. The material dampens noise and contributes to restful acoustics in residential buildings, industrial premises, public spaces etc. BAUX is well equipped to absorb human voice frequencies (between 500-4000Hz) and is therefore often used in public spaces, offices and schools. BAUX wood wool 25 mm thickness, directly installed on the wall or ceiling performs NRC 0.40 and Alpha-w 0.30. The 3D PIXEL product with an even distribution of thicknesses 25/50/70mm perform NRC 0.60 and Alpha-w 0.50 when installed direct on the wall or ceiling. To reach higher absorption coefficients you can also use BAUX together with a 40 mm acoustic stone wool board. In this case you can reach NRC 0.95 and Alpha-w 1.0 (class-A).

Cleaning

BAUX Acoustic Wood Wool products can be cleaned with a vacuum cleaner without being harmed. Use a brush attachment and put light pressure on the surface. Dirt attached to the surface may be removed with a brush or a wet rag. Cleaning liquids may be used. In cases of heavy soiling, light cleaning with hot steam is proposed.

Repairs

appearance since the boards have the same structure throughout the entire product. Minor damages can be re-painted. Boards with larger damages need to be replaced.

Reuse, Recycling and Deposition

Boards that have been disassembled in connection with renovation or demolition may be reused. Wood wool boards may be ground down and recycled, e.g., as ballast and filling material, moisture absorbent sprinkling, substrate for running tracks etc. If wood wool material is deposited in nature, no negative environmental impact arises, on the contrary it adds a calcium supplement. When CO₂ from the air binds to the cement particles, calcium is formed (carbonation).

BAUX

Let's build!